

Nipomo Mesa Supplemental Water Project Assessment District No. 1

Nipomo Community Services District
State of California



Part V

Assessment Diagram

For
Rural Water Company

February 2012 Draft



ASSESSMENT DIAGRAM

NIPOMO MESA
SUPPLEMENTAL
SERVICES DISTRICT
ASSESSMENT DISTRICT
NO.1

NIPOMO COMMUNITY
SERVICES DISTRICT
STATE OF CALIFORNIA

- Legend**
- ASSM BOUNDARY
 - ASSESSOR PARCEL
 - DIAGRAM SHEET

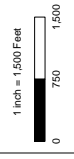

SHEET:
1 OF 28

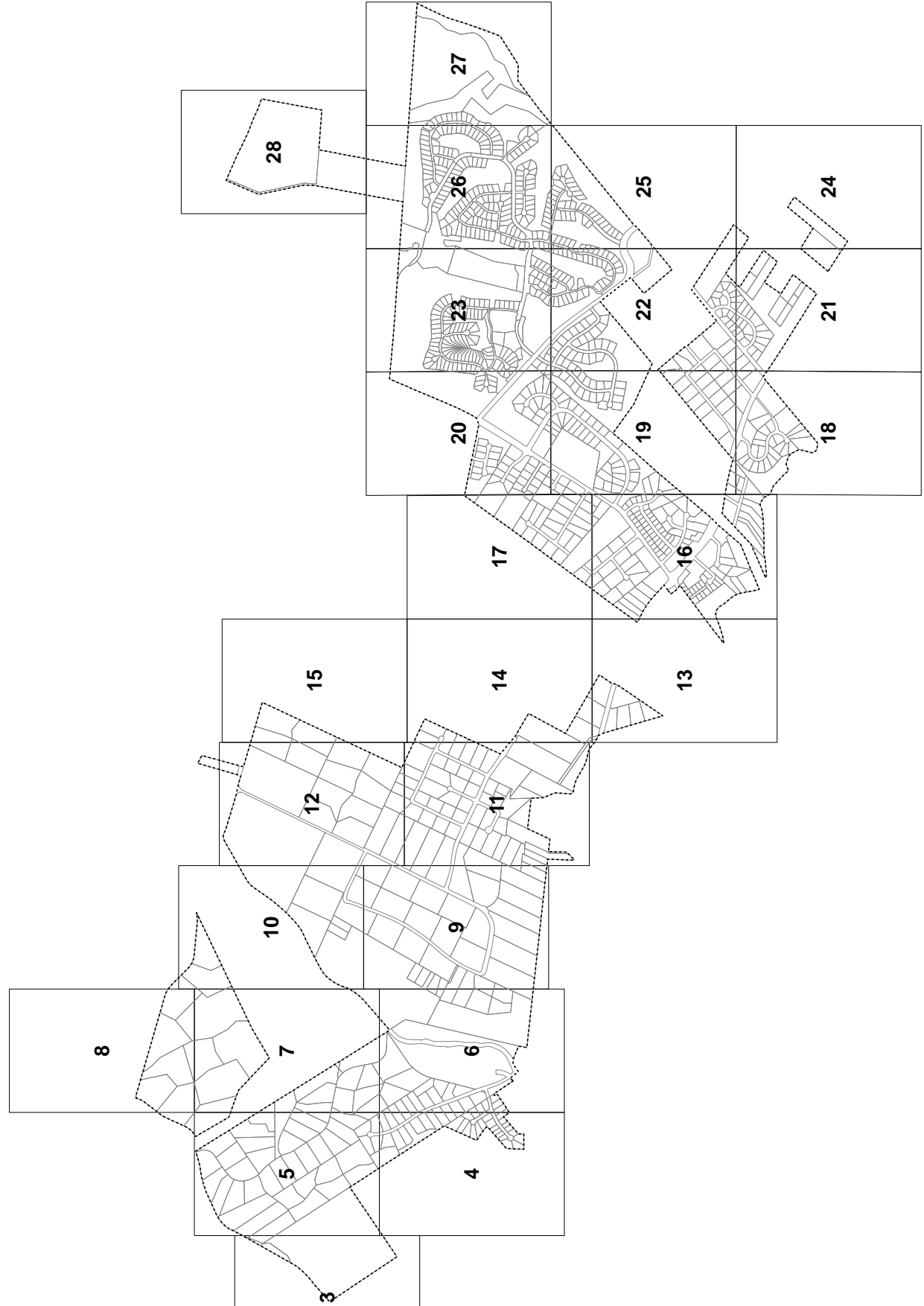

LOTS ON THIS SHEET ARE
BASED ON ASSESSORS
MAP COUNTY OF SAN LUIS
OBISPO COUNTY, CALIFORNIA
041, 042, 051, 061, 150, 151,
160, 161, 162, 164, 165, 171,
181, 202, 203, 204, 211, 241,
251, 252, 253, 254, 255,
364, 365, 380, 381, 392, 393,
400, 401, 402, 403, 404, 405,
406, 407, 408, 409, 410, 411,
412.

ASSESSMENT NUMBER INDEX



<u>SHEET NUMBER:</u>	<u>ASSESSMENT NUMBER:</u>
SHEET 3	0001-0003
SHEET 4	0004-0039
SHEET 5	0040-0078
SHEET 6	0079-0105
SHEET 7	0106-0120
SHEET 8	0121-0125
SHEET 9	0126-0154
SHEET 10	0155-0162
SHEET 11	0163-0216
SHEET 12	0217-0234
SHEET 13	0235-0241
SHEET 14	0242-0246
SHEET 15	0247-0248
SHEET 16	0249-0374
SHEET 17	0375-0399
SHEET 18	0400-0431
SHEET 19	0432-0513
SHEET 20	0514-0569
SHEET 21	0570-0599
SHEET 22	0600-0700
SHEET 23	0701-0835
SHEET 24	0836
SHEET 25	0837-0881
SHEET 26	0882-1069
SHEET 27	1070-1083
SHEET 28	1084-1085

**ASSESSMENT
DIAGRAM**

NIPOMO MESA
SUPPLEMENTAL
SERVICES DISTRICT
ASSESSMENT DISTRICT
NO.1

NIPOMO COMMUNITY
SERVICES DISTRICT
STATE OF CALIFORNIA

Legend

-  ASSESSOR PARCEL
-  ASSESSOR PARCEL
-  ASSESSOR PARCEL

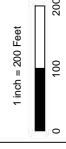

**SHEET:
3 OF 28**

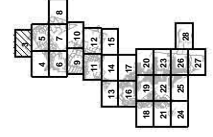

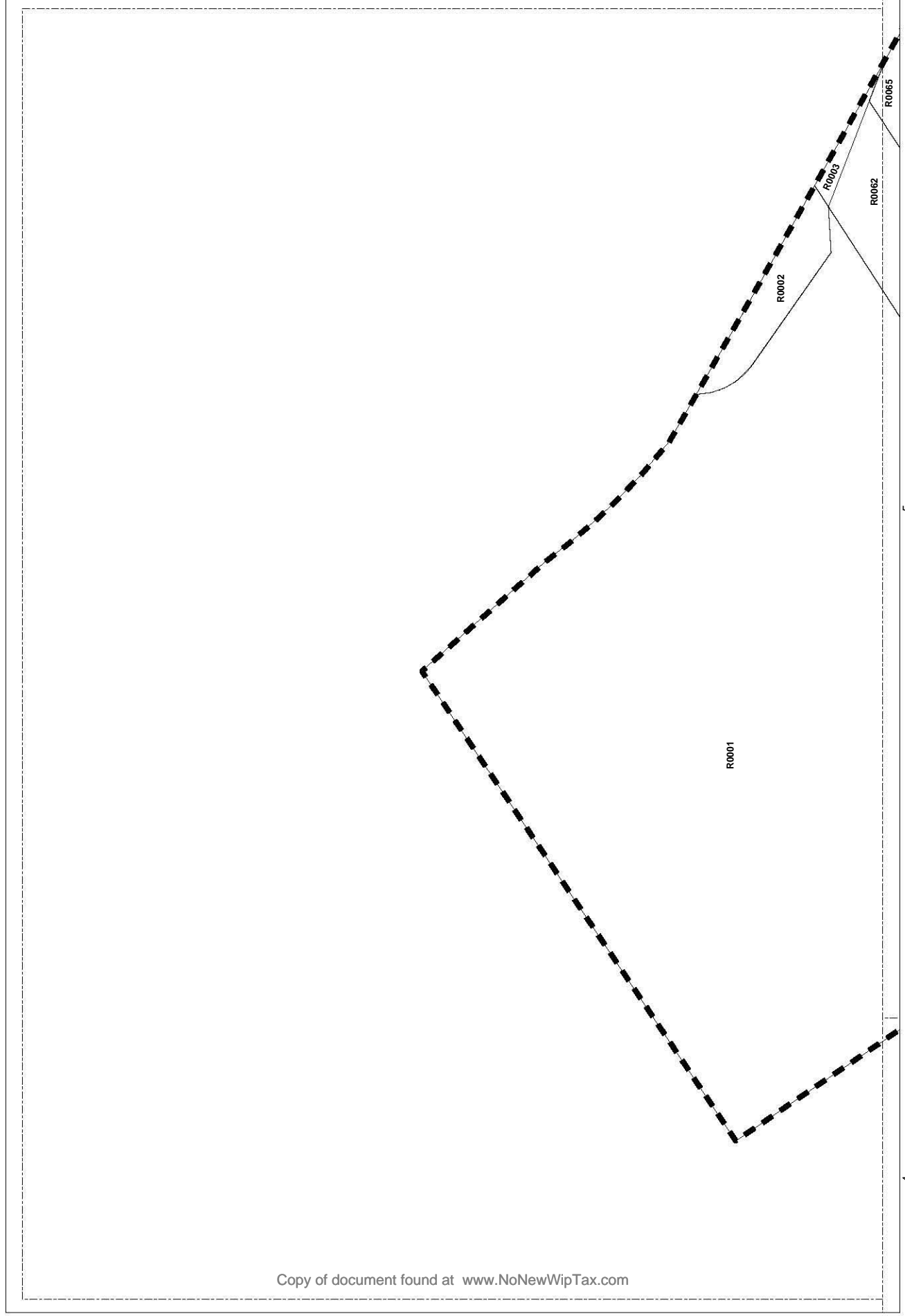

LOTS ON THIS SHEET ARE
BASED ON ASSESSORS
MAP COUNTY OF SAN LUIS
OBISPO COUNTY, CALIFORNIA
0481, 0482, 051, 061, 061, 150, 151,
160, 161, 162, 164, 165, 171,
181, 202, 203, 204, 211, 241,
242, 243, 244, 245, 246,
364, 365, 380, 381, 382, 383,
400, 401, 402, 403, 404, 405,
406, 407, 408, 409, 410, 411,
412



ASSESSMENT DIAGRAM

NIPOMO MESA
SUPPLEMENTAL
MAP COUNTY OF SAN LUIS
OBISPO
ASSESSMENT DISTRICT
NO. 1

NIPOMO COMMUNITY
SERVICES DISTRICT
STATE OF CALIFORNIA

- Legend**
-  ASSESSOR PARCEL
 -  ASSESSOR BOUNDARY
 -  DIAGRAM SHEET

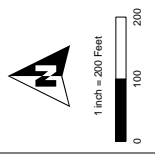

SHEET:
4 OF 28





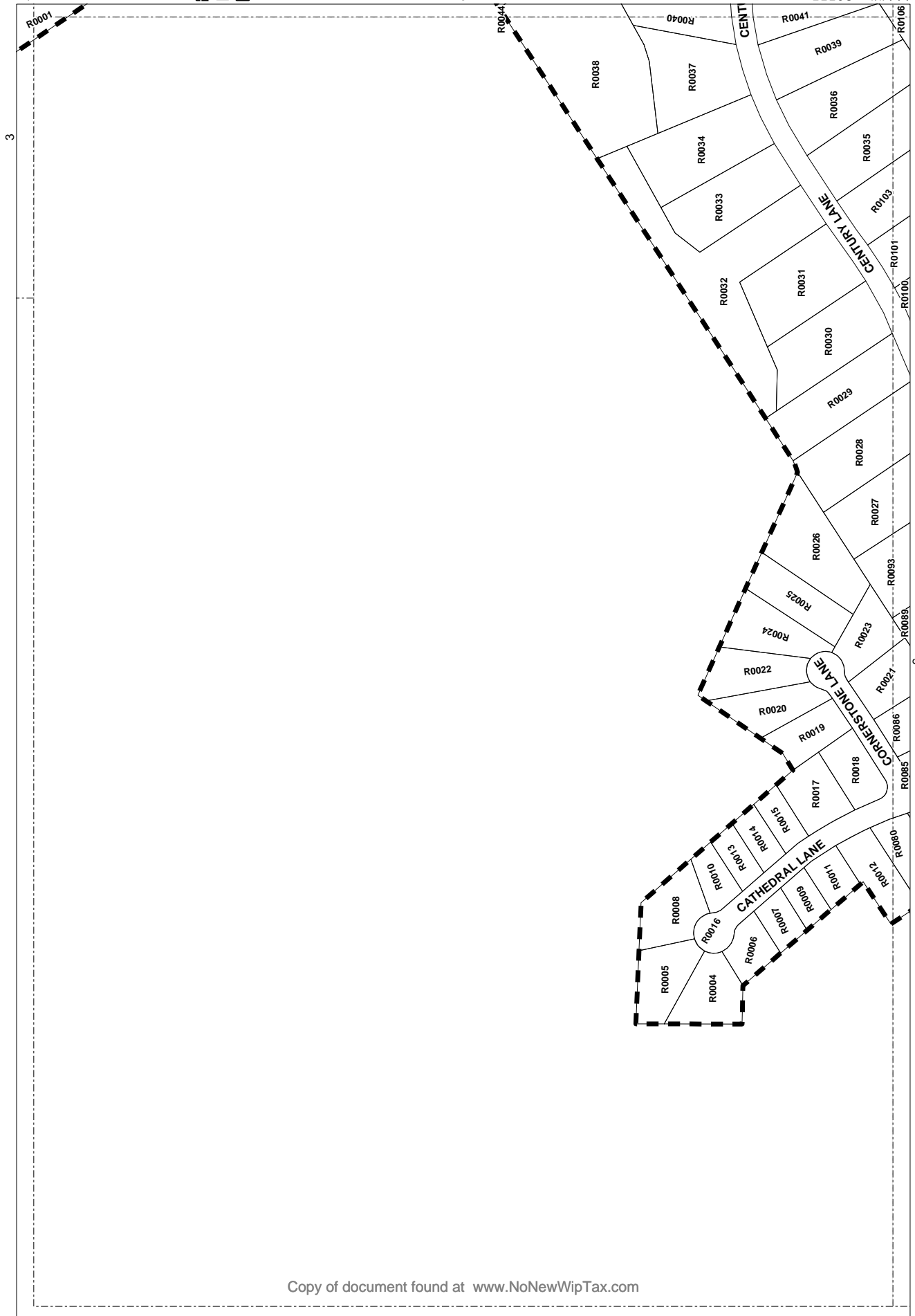

LOTS ON THIS SHEET ARE
BASED ON ASSESSORS
MAP COUNTY OF SAN LUIS
OBISPO
041, 042, 051, 061, 062, 063, 064, 065, 066, 067, 068, 069, 070, 071, 072, 073, 074, 075, 076, 077, 078, 079, 080, 081, 082, 083, 084, 085, 086, 087, 088, 089, 090, 091, 092, 093, 094, 095, 096, 097, 098, 099, 100, 101, 102, 103, 104, 105, 106, 107, 108, 109, 110, 111, 112, 113, 114, 115, 116, 117, 118, 119, 120, 121, 122, 123, 124, 125, 126, 127, 128, 129, 130, 131, 132, 133, 134, 135, 136, 137, 138, 139, 140, 141, 142, 143, 144, 145, 146, 147, 148, 149, 150, 151, 152, 153, 154, 155, 156, 157, 158, 159, 160, 161, 162, 163, 164, 165, 166, 167, 168, 169, 170, 171, 172, 173, 174, 175, 176, 177, 178, 179, 180, 181, 182, 183, 184, 185, 186, 187, 188, 189, 190, 191, 192, 193, 194, 195, 196, 197, 198, 199, 200, 201, 202, 203, 204, 205, 206, 207, 208, 209, 210, 211, 212, 213, 214, 215, 216, 217, 218, 219, 220, 221, 222, 223, 224, 225, 226, 227, 228, 229, 230, 231, 232, 233, 234, 235, 236, 237, 238, 239, 240, 241, 242, 243, 244, 245, 246, 247, 248, 249, 250, 251, 252, 253, 254, 255, 256, 257, 258, 259, 260, 261, 262, 263, 264, 265, 266, 267, 268, 269, 270, 271, 272, 273, 274, 275, 276, 277, 278, 279, 280, 281, 282, 283, 284, 285, 286, 287, 288, 289, 290, 291, 292, 293, 294, 295, 296, 297, 298, 299, 300, 301, 302, 303, 304, 305, 306, 307, 308, 309, 310, 311, 312, 313, 314, 315, 316, 317, 318, 319, 320, 321, 322, 323, 324, 325, 326, 327, 328, 329, 330, 331, 332, 333, 334, 335, 336, 337, 338, 339, 340, 341, 342, 343, 344, 345, 346, 347, 348, 349, 350, 351, 352, 353, 354, 355, 356, 357, 358, 359, 360, 361, 362, 363, 364, 365, 366, 367, 368, 369, 370, 371, 372, 373, 374, 375, 376, 377, 378, 379, 380, 381, 382, 383, 384, 385, 386, 387, 388, 389, 390, 391, 392, 393, 394, 395, 396, 397, 398, 399, 400, 401, 402, 403, 404, 405, 406, 407, 408, 409, 410, 411, 412.



**ASSESSMENT
DIAGRAM**

NIPOMO MESA
SUPPLEMENTAL
ASSESSMENT DISTRICT
NO.1

NIPOMO COMMUNITY
SERVICES DISTRICT
STATE OF CALIFORNIA

- Legend**
-  ASSESSOR PARCEL
 -  ASSESSOR PARCEL
 -  ASSESSOR PARCEL
 -  ASSESSOR PARCEL
 -  ASSESSOR PARCEL

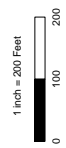

**SHEET:
5 OF 28**





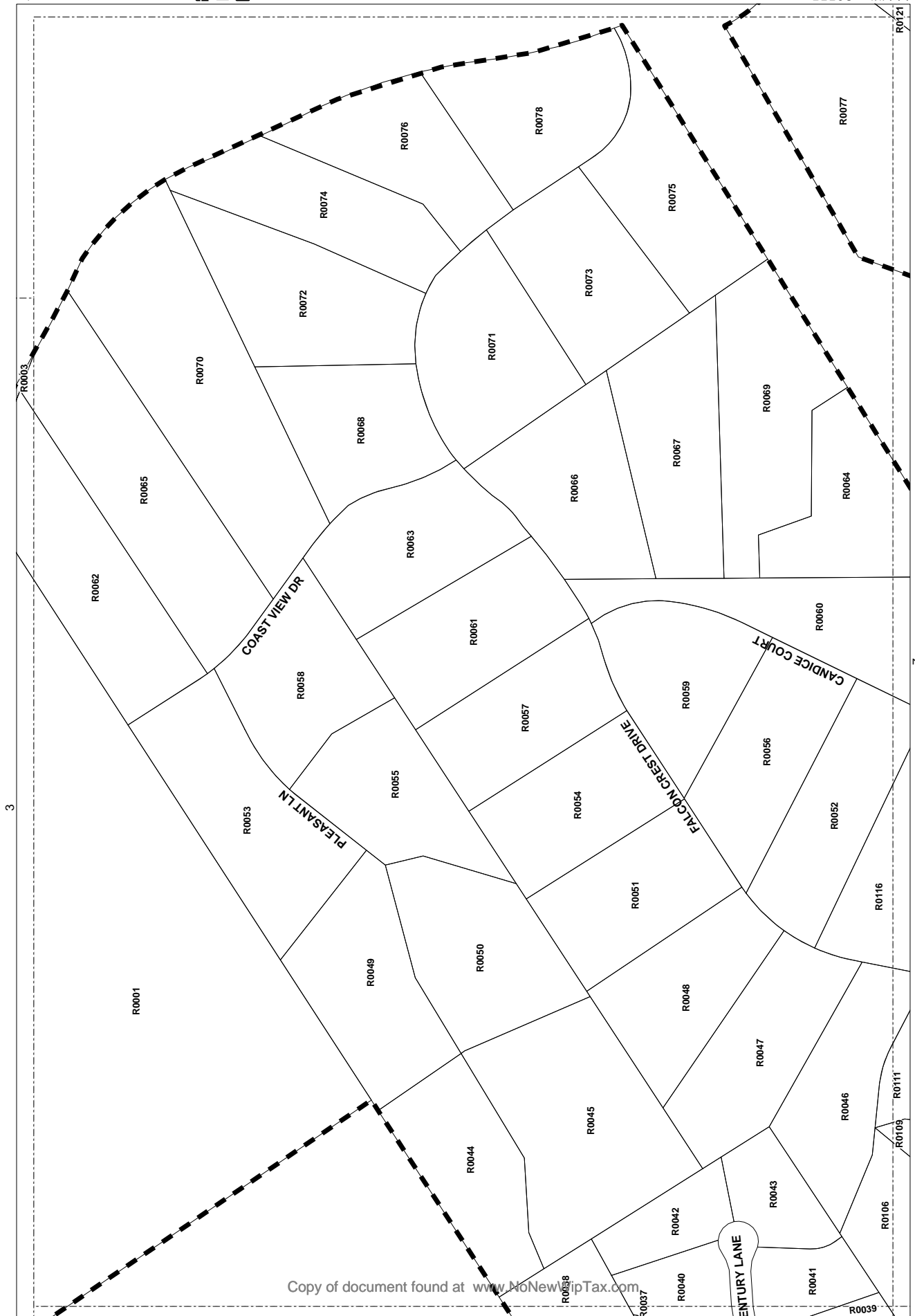

LOTS ON THIS SHEET ARE
BASED ON ASSESSORS
MAP COUNTY OF SAN LUIS
OBSERVED 05/05/2011
041, 042, 051, 061, 150, 151,
160, 161, 162, 164, 165, 171,
181, 202, 203, 204, 211, 241,
242, 243, 244, 245, 246,
364, 365, 380, 381, 382, 383,
400, 401, 402, 403, 404, 405,
406, 407, 408, 409, 410, 411,
412.



**ASSESSMENT
DIAGRAM**

NIPOMO MESA
SUPPLEMENTAL
ASSESSMENT DISTRICT
NO. 1

NIPOMO COMMUNITY
SERVICES DISTRICT
STATE OF CALIFORNIA

- Legend**
-  ASSESSOR PARCEL
 -  ASSESSOR BOUNDARY
 -  ASSESSOR PARCEL
 -  DIAGRAM SHEET

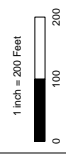

**SHEET:
6 OF 28**









LOTS ON THIS SHEET ARE
BASED ON ASSESSORS
MAP COUNTY OF SAN LUIS
OBSERVED BY THE ASSESSOR
04/10/2009 09:11 AM 150 151,
160, 161, 162, 164, 165, 171,
181, 202, 203, 204, 211, 241,
242, 243, 244, 245, 246,
364, 365, 390, 391, 392, 393,
400, 401, 402, 403, 404, 405,
406, 407, 408, 409, 410, 411,
412.



**ASSESSMENT
DIAGRAM**

NIPOMO MESA
SUPPLEMENTAL
MAP NO. 1
ASSESSMENT DISTRICT
NO. 1

NIPOMO COMMUNITY
SERVICES DISTRICT
STATE OF CALIFORNIA

- Legend**
-  ASSESSOR PARCEL
 -  ASSESSOR BOUNDARY
 -  ASSESSOR PARCEL
 -  ASSESSOR BOUNDARY
 -  ASSESSOR PARCEL
 -  ASSESSOR BOUNDARY

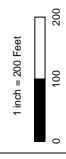

**SHEET:
7 OF 28**



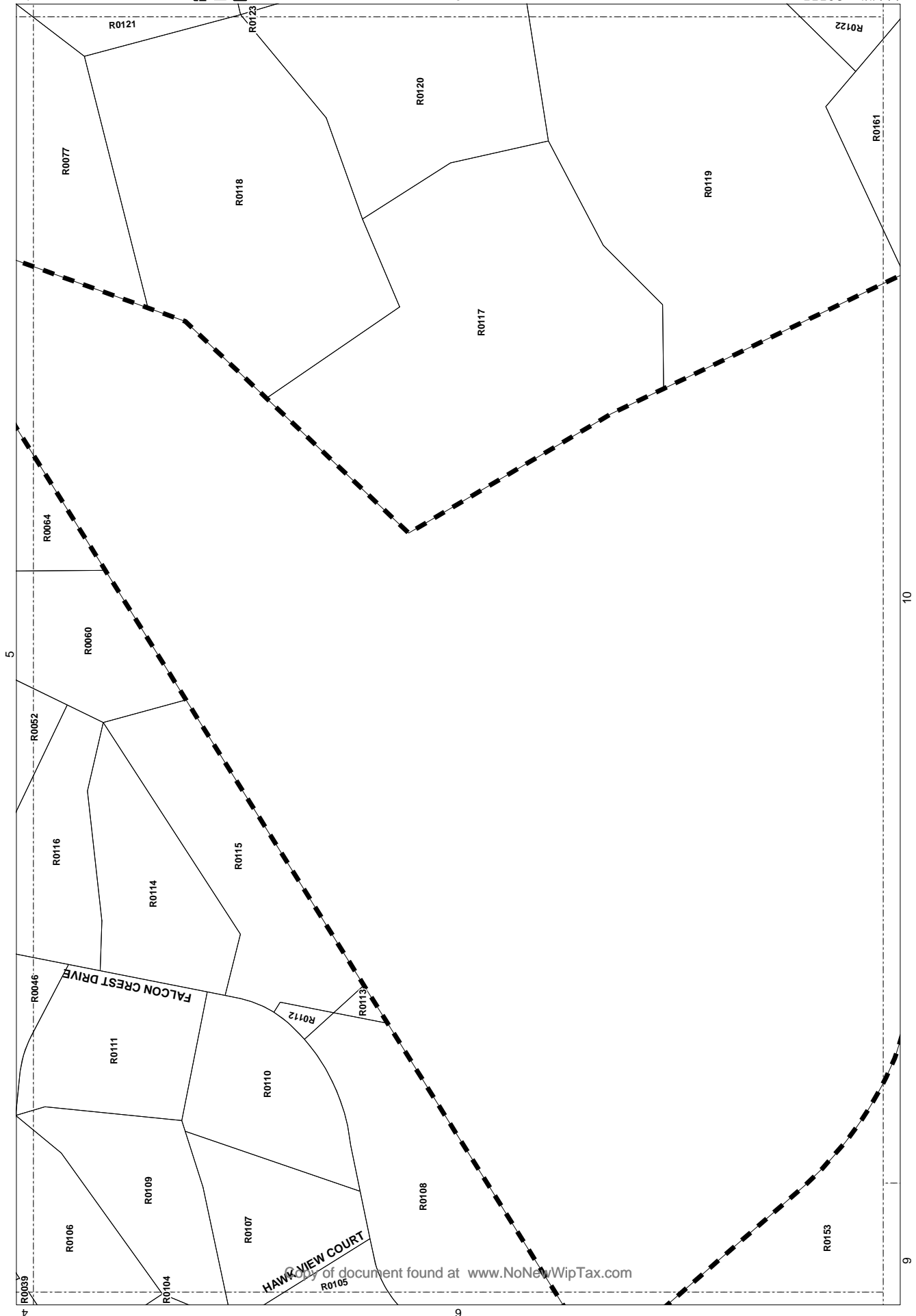

LOTS ON THIS SHEET ARE
BASED ON ASSESSORS
MAP COUNTY OF SAN LUIS
OBSOLETE MAP NO. 1
041, 042, 051, 061, 150, 151,
160, 161, 162, 164, 165, 171,
181, 202, 203, 204, 211, 241,
242, 243, 244, 245, 246,
364, 365, 380, 381, 382, 383,
400, 401, 402, 403, 404, 405,
406, 407, 408, 409, 410, 411,
412.



**ASSESSMENT
DIAGRAM**

NIPOMO MESA
SUPPLEMENTAL
ASSESSMENT DISTRICT
NO.1

NIPOMO COMMUNITY
SERVICES DISTRICT
STATE OF CALIFORNIA

- Legend**
-  ASSM BOUNDARY
 -  ASSESSOR PARCEL
 -  DIAGRAM SHEET

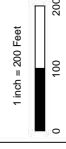

**SHEET:
8 OF 28**





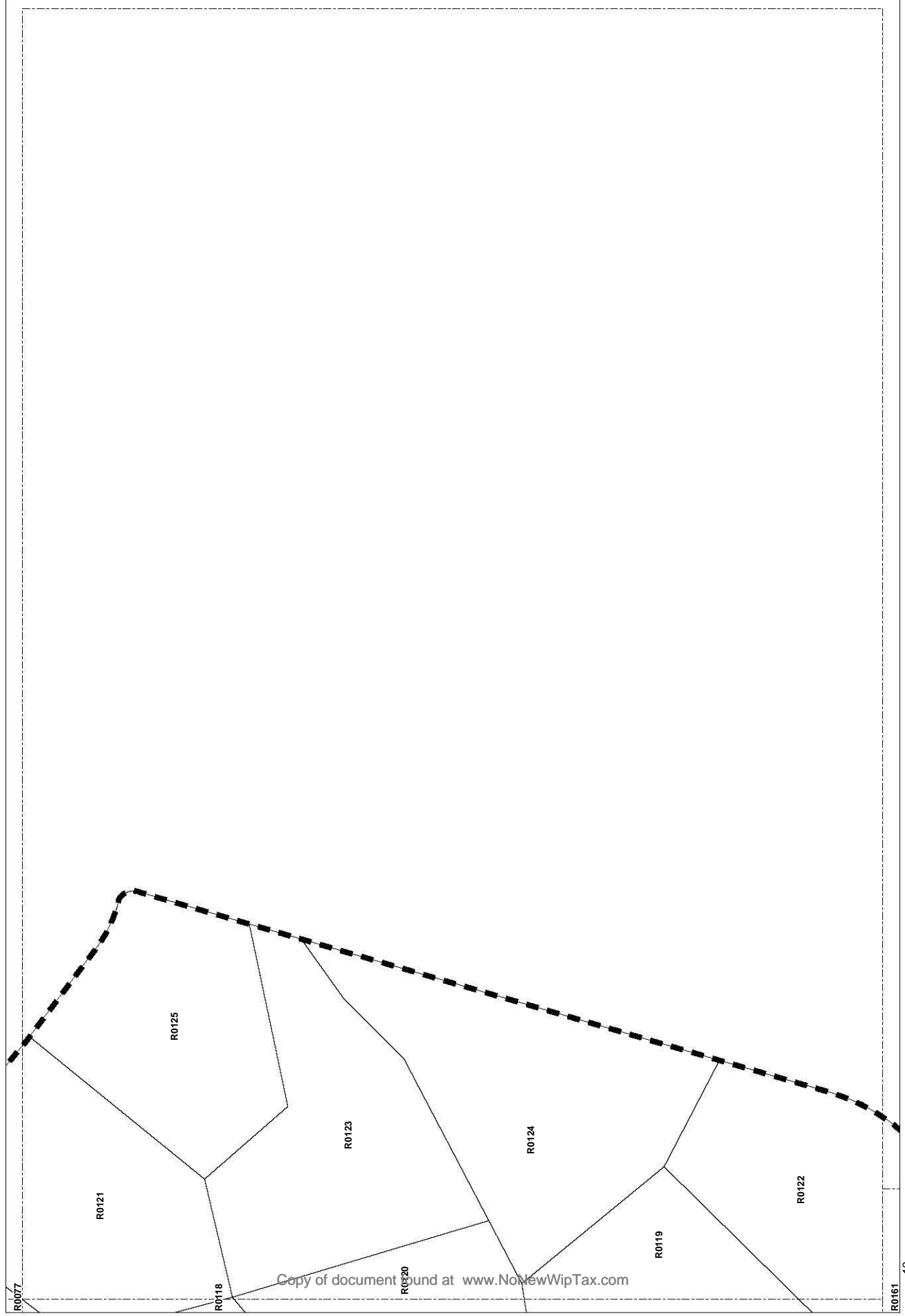

LOTS ON THIS SHEET ARE
BASED ON ASSESSORS
MAP COUNTY OF SAN LUIS
OBSOLETE MAPS 1921-
0401, 042, 051, 061, 150, 151,
160, 161, 162, 164, 165, 171,
181, 202, 203, 204, 211, 241,
242, 243, 244, 245, 246,
364, 365, 380, 381, 382, 383,
400, 401, 402, 403, 404, 405,
406, 407, 408, 409, 410, 411,
412.



**ASSESSMENT
DIAGRAM**

NIPOMO MESA
SUPPLEMENTAL
SERVICES DISTRICT
ASSESSMENT DISTRICT
NO.1

NIPOMO COMMUNITY
SERVICES DISTRICT
STATE OF CALIFORNIA

- Legend**
-  ASSESSOR PARCEL
 -  ASSESSOR PARCEL
 -  ASSESSOR PARCEL
 -  ASSESSOR PARCEL

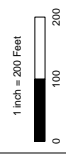

**SHEET:
10 OF 28**



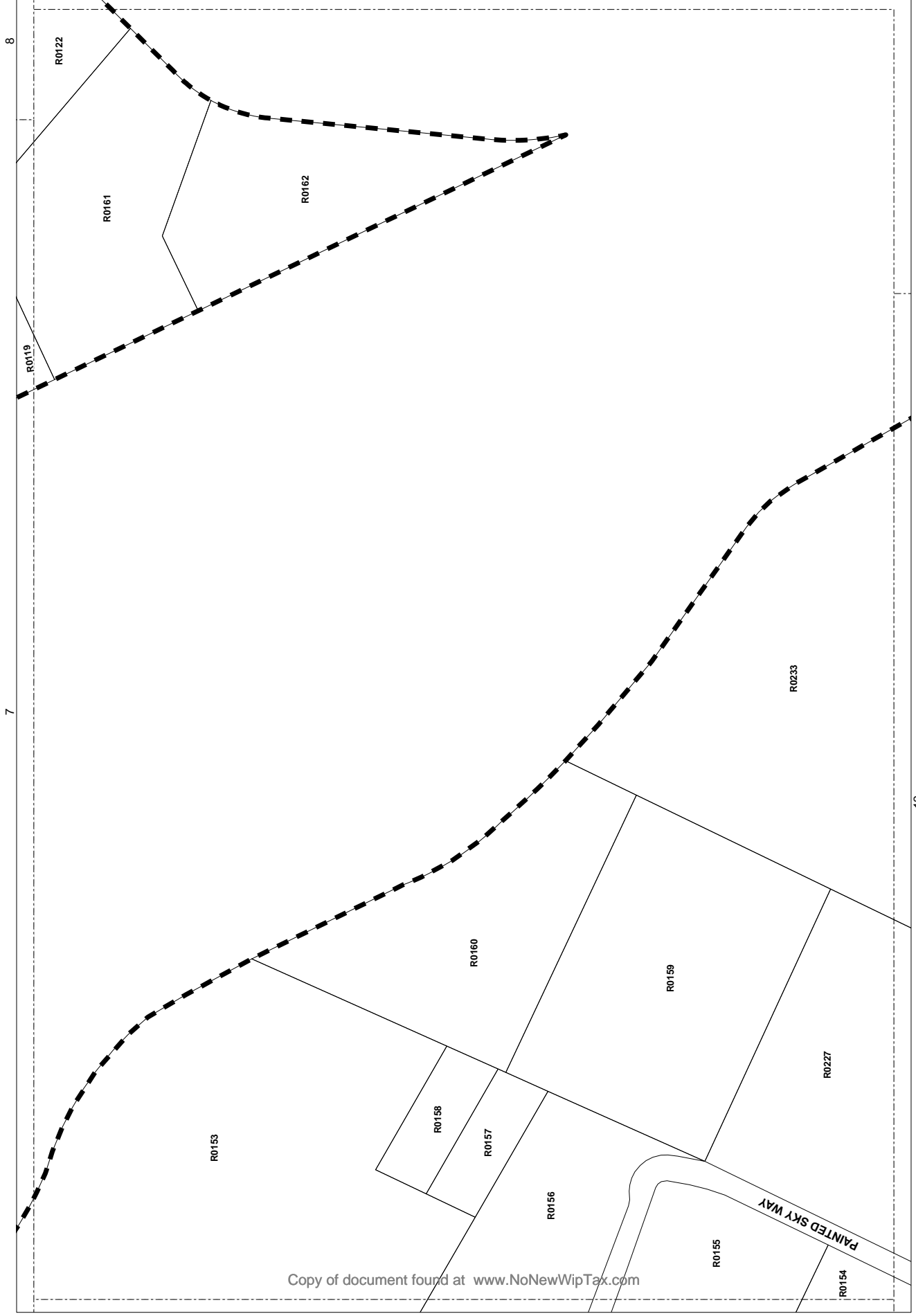

LOTS ON THIS SHEET ARE
BASED ON ASSESSORS
MAP COUNTY OF SAN LUIS
OBISPO COUNTY OFFICE 10/21/11
0481 042 051 061 061 150 151
160 161 162 164 165 171
181 202 203 204 211 241
242 243 244 245 246 247
364 365 380 381 382 383
400 401 402 403 404 405
406 407 408 409 410 411
412



**ASSESSMENT
DIAGRAM**

NIPOMO MESA
SUPPLEMENTAL
ASSESSMENT DISTRICT
NO. 1

NIPOMO COMMUNITY
SERVICES DISTRICT
STATE OF CALIFORNIA

- Legend**
-  ASSM BOUNDARY
 -  ASSESSOR PARCEL
 -  DIAGRAM SHEET

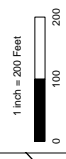

12

**SHEET:
11 OF 28**



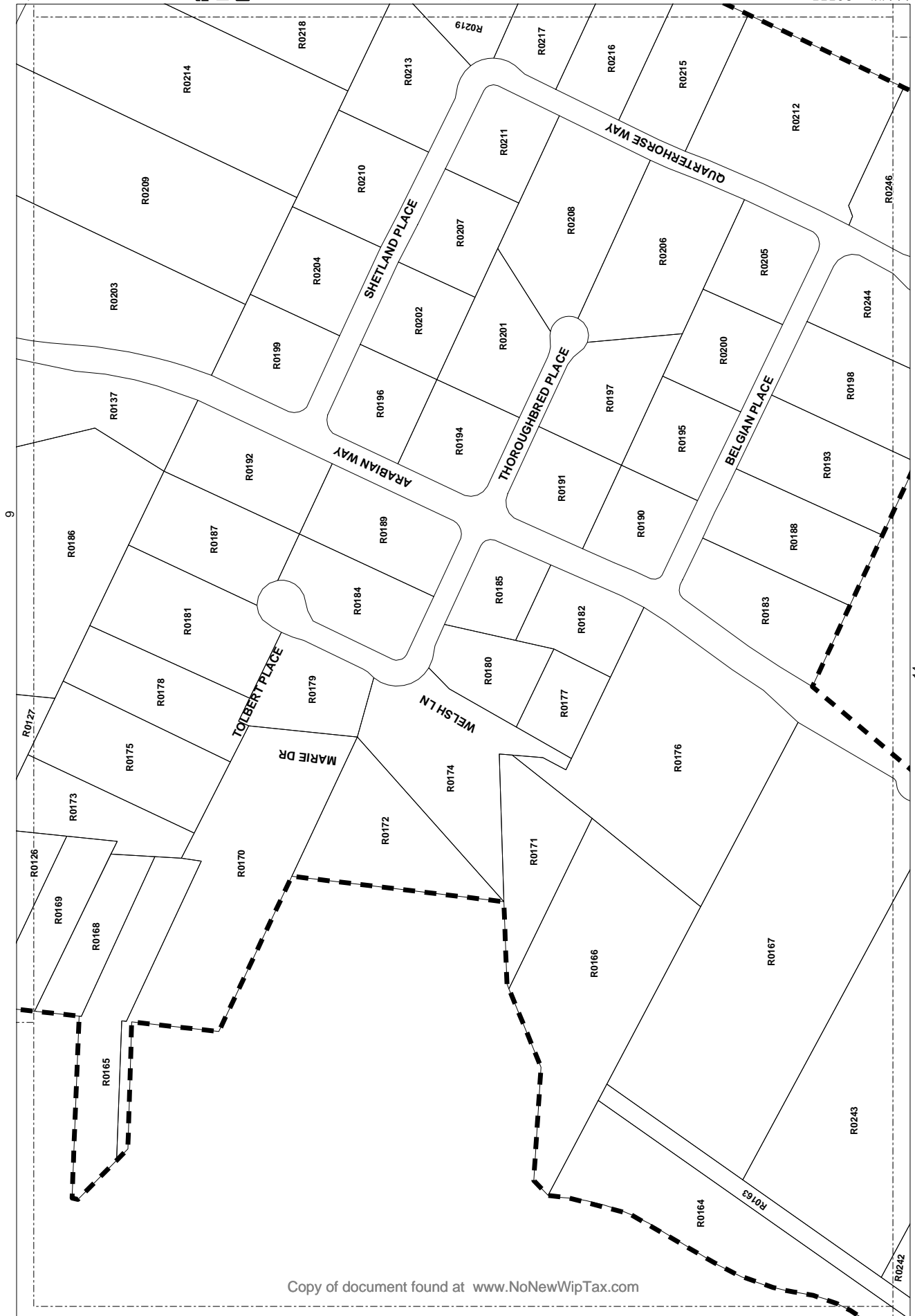

LOTS ON THIS SHEET ARE
BASED ON ASSESSORS
MAP COUNTY OF SAN LUIS
OBISPO COUNTY, CALIFORNIA
041, 042, 051, 061, 061, 150, 151,
160, 161, 162, 164, 165, 171,
181, 202, 203, 204, 211, 241,
242, 243, 244, 245, 246,
364, 365, 380, 381, 382, 383,
400, 401, 402, 403, 404, 405,
406, 407, 408, 409, 410, 411,
412.



**ASSESSMENT
DIAGRAM**

NIPOMO MESA
SUPPLEMENTAL
ASSASSMENT DISTRICT
NO.1

NIPOMO COMMUNITY
SERVICES DISTRICT
STATE OF CALIFORNIA

- Legend**
-  ASSESSOR PARCEL
 -  ASSESSOR PARCEL
 -  ASSESSOR PARCEL

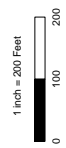

**SHEET:
12 OF 28**



LOTS ON THIS SHEET ARE
BASED ON ASSESSORS
MAP COUNTY OF SAN LUIS
OBSOLETE MAPS:
0481, 042, 051, 061, 150, 151,
160, 161, 162, 164, 165, 171,
181, 202, 203, 204, 211, 241,
242, 243, 244, 245, 246,
364, 365, 380, 381, 382, 383,
400, 401, 402, 403, 404, 405,
406, 407, 408, 409, 410, 411,
412.

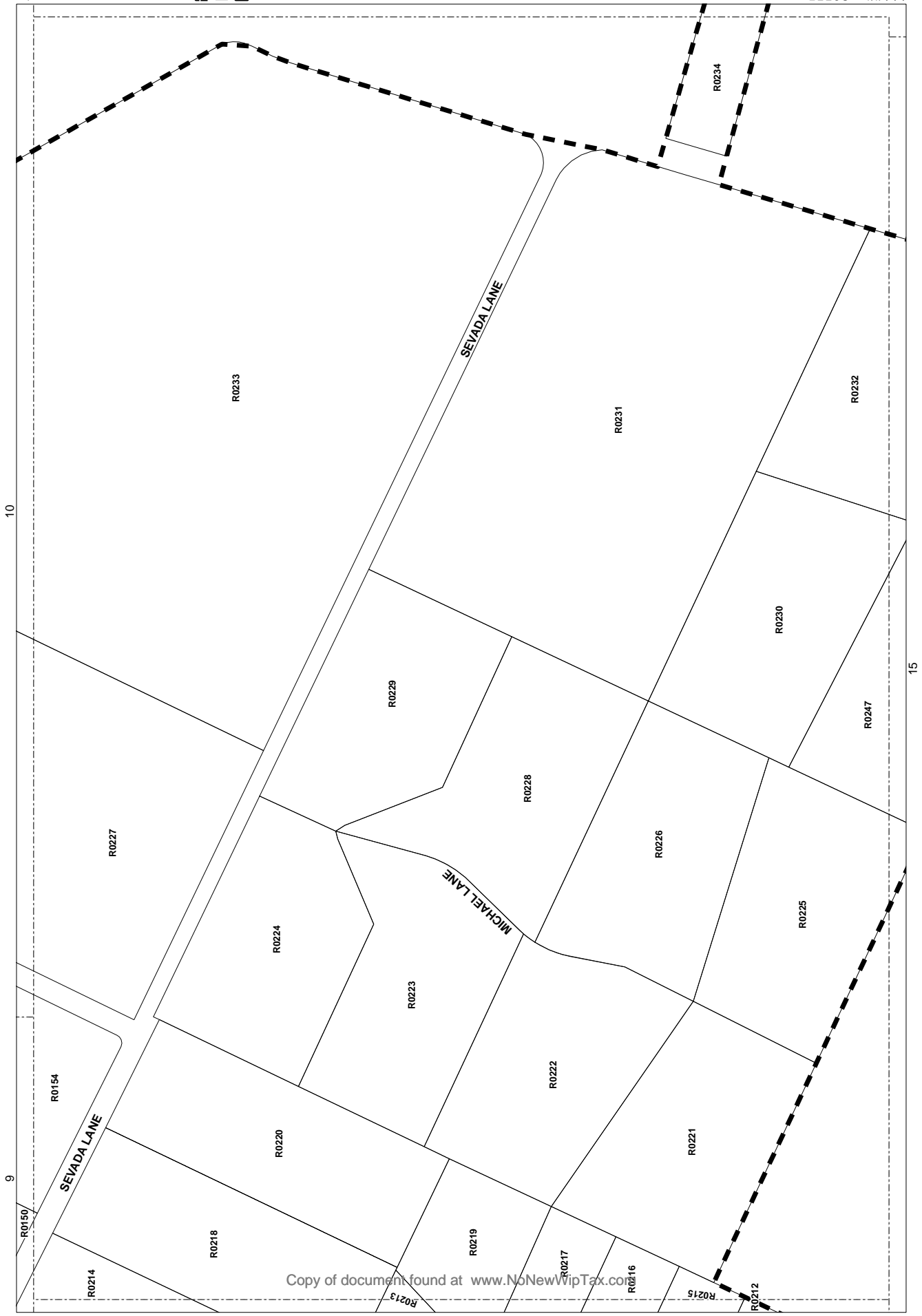





**ASSESSMENT
DIAGRAM**

NIPOMO MESA
SUPPLEMENTAL
SERVICES DISTRICT
ASSESSMENT DISTRICT
NO.1

NIPOMO COMMUNITY
SERVICES DISTRICT
STATE OF CALIFORNIA

Legend

-  ASSESSOR PARCEL
-  ASSESSOR PARCEL
-  ASSESSOR PARCEL
-  DIAGRAM SHEET

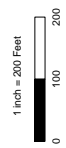

14

**SHEET:
13 OF 28**



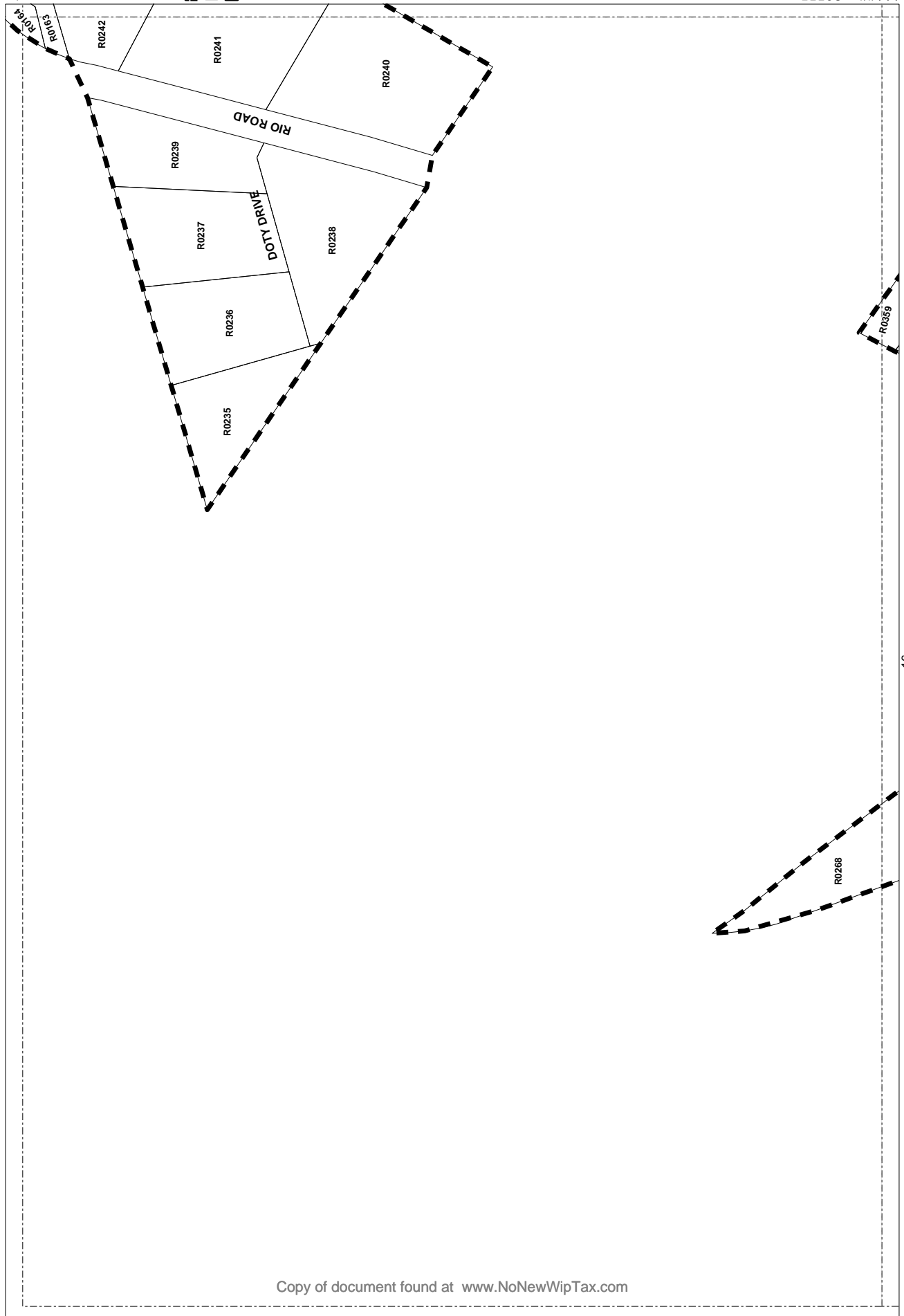

LOTS ON THIS SHEET ARE
BASED ON ASSESSORS
MAP COUNTY OF SAN LUIS
OBISPO COUNTY, 1992-1993
0481, 042, 051, 061, 150, 151,
160, 161, 162, 164, 165, 171,
181, 202, 203, 204, 211, 241,
242, 243, 244, 245, 246,
364, 365, 380, 381, 382, 383,
400, 401, 402, 403, 404, 405,
406, 407, 408, 409, 410, 411,
412.



**ASSESSMENT
DIAGRAM**

NIPOMO MESA
SUPPLEMENTAL
ASSESSMENT DISTRICT
NO.1

NIPOMO COMMUNITY
SERVICES DISTRICT
STATE OF CALIFORNIA

- Legend**
-  ASSESSMENT BOUNDARY
 -  ASSESSOR PARCEL
 -  DIAGRAM SHEET

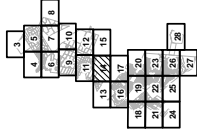
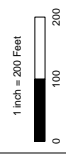

LOTS ON THIS SHEET ARE
BASED ON ASSESSORS
MAP COUNTY OF SAN LUIS
OCEANOGRAPHIC SERVICES DISTRICT
NO.1
0481, 042, 051, 061, 150, 151,
160, 161, 162, 164, 165, 171,
181, 202, 203, 204, 211, 241,
242, 243, 244, 245, 246,
364, 365, 380, 381, 382, 383,
400, 401, 402, 403, 404, 405,
406, 407, 408, 409, 410, 411,
412.

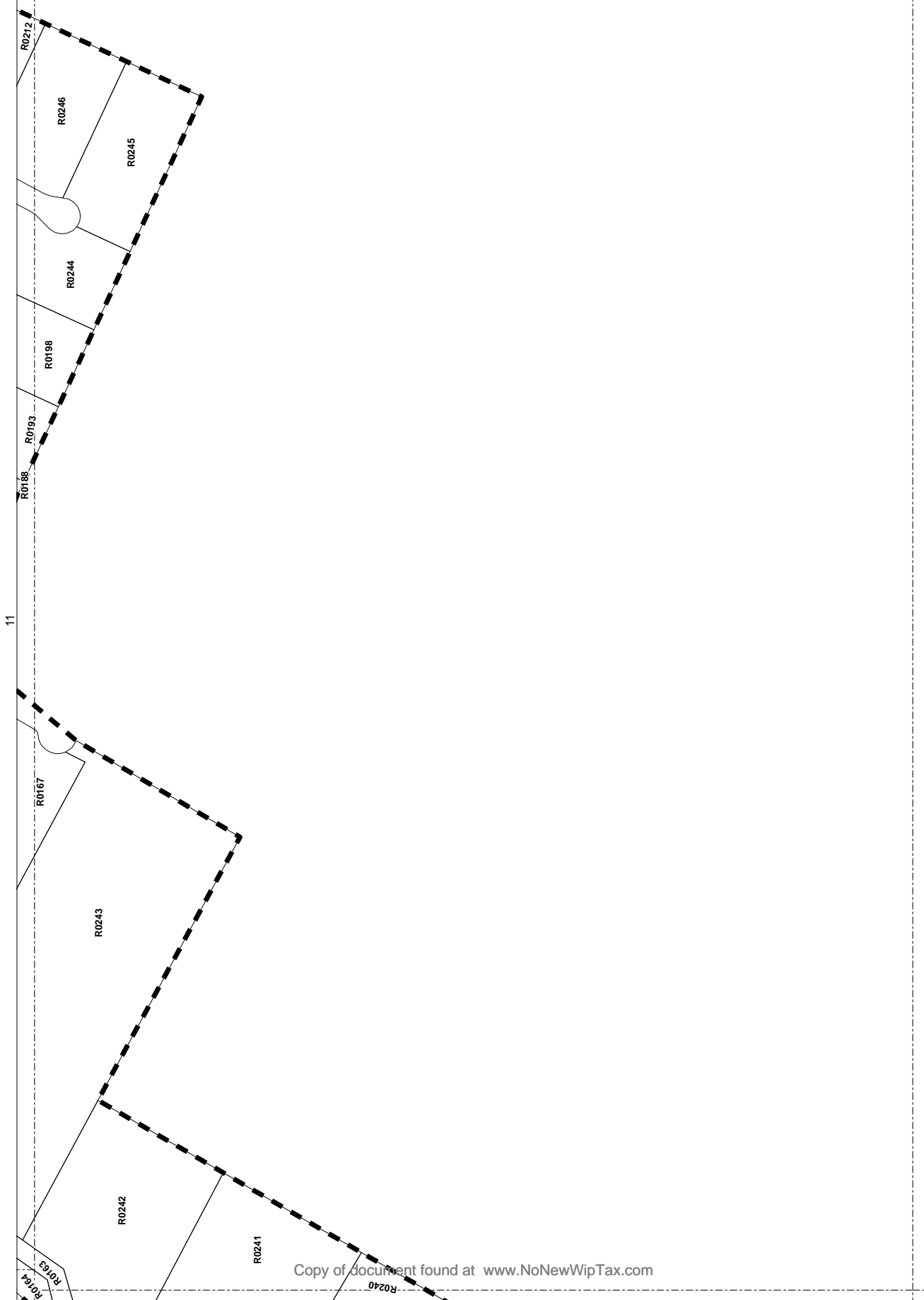







Copy of document found at www.NoNewWipTax.com

**ASSESSMENT
DIAGRAM**

NIPOMO MESA
SUPPLEMENTAL
SERVICES DISTRICT
ASSESSMENT DISTRICT
NO.1

NIPOMO COMMUNITY
SERVICES DISTRICT
STATE OF CALIFORNIA

- Legend**
-  ASSESSOR PARCEL
 -  ASSESSOR PARCEL
 -  ASSESSOR PARCEL
 -  ASSESSOR PARCEL
 -  ASSESSOR PARCEL
 -  ASSESSOR PARCEL

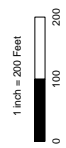

**SHEET:
15 OF 28**



LOTS ON THIS SHEET ARE
BASED ON ASSESSORS
MAP COUNTY OF SAN LUIS
OBISPO COUNTY, 1992-93
0481 042 051 061 150 151
160 161 162 164 165 171
181 202 203 204 211 241
242 243 244 245 246
364 365 380 381 382 383
400 401 402 403 404 405
406 407 408 409 410 411
412

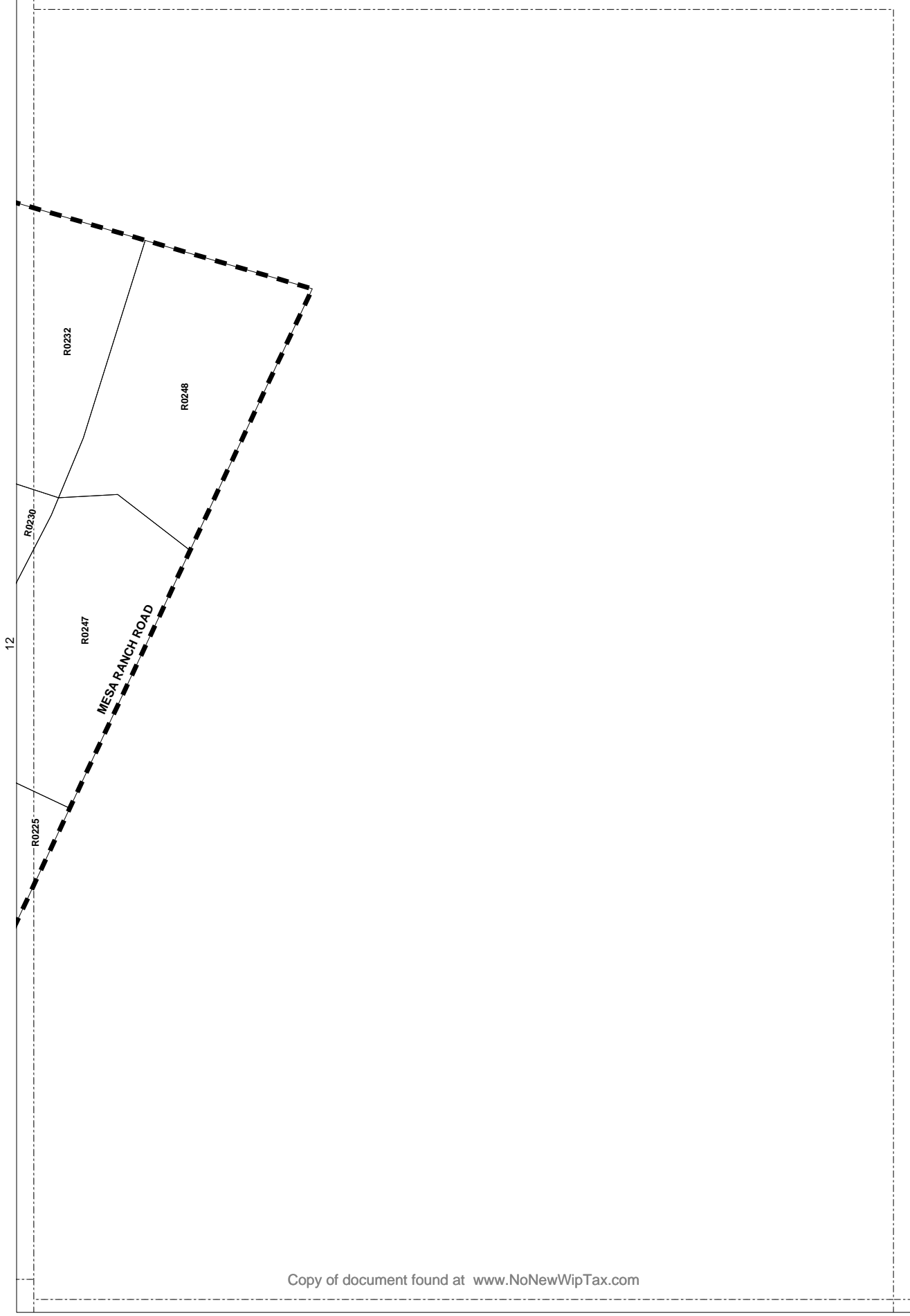



**ASSESSMENT
DIAGRAM**

NIPOMO MESA
SUPPLEMENTAL
ASSESSMENT DISTRICT
NO. 1

NIPOMO COMMUNITY
SERVICES DISTRICT
STATE OF CALIFORNIA

Legend

-  ASSM BOUNDARY
-  ASSESSOR PARCEL
-  DIAGRAM SHEET

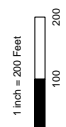

17

**SHEET:
16 OF 28**

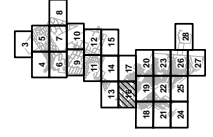

LOTS ON THIS SHEET ARE
BASED ON ASSESSORS
MAP COUNTY OF SAN LUIS
OBISPO COUNTY DISTRICT
041 042 051 061 065 101
160 161 162 164 165 171
181 202 203 204 211 241
251 252 253 254 255 256
364 365 366 381 382 383
400 401 402 403 404 405
406 407 408 409 410 411

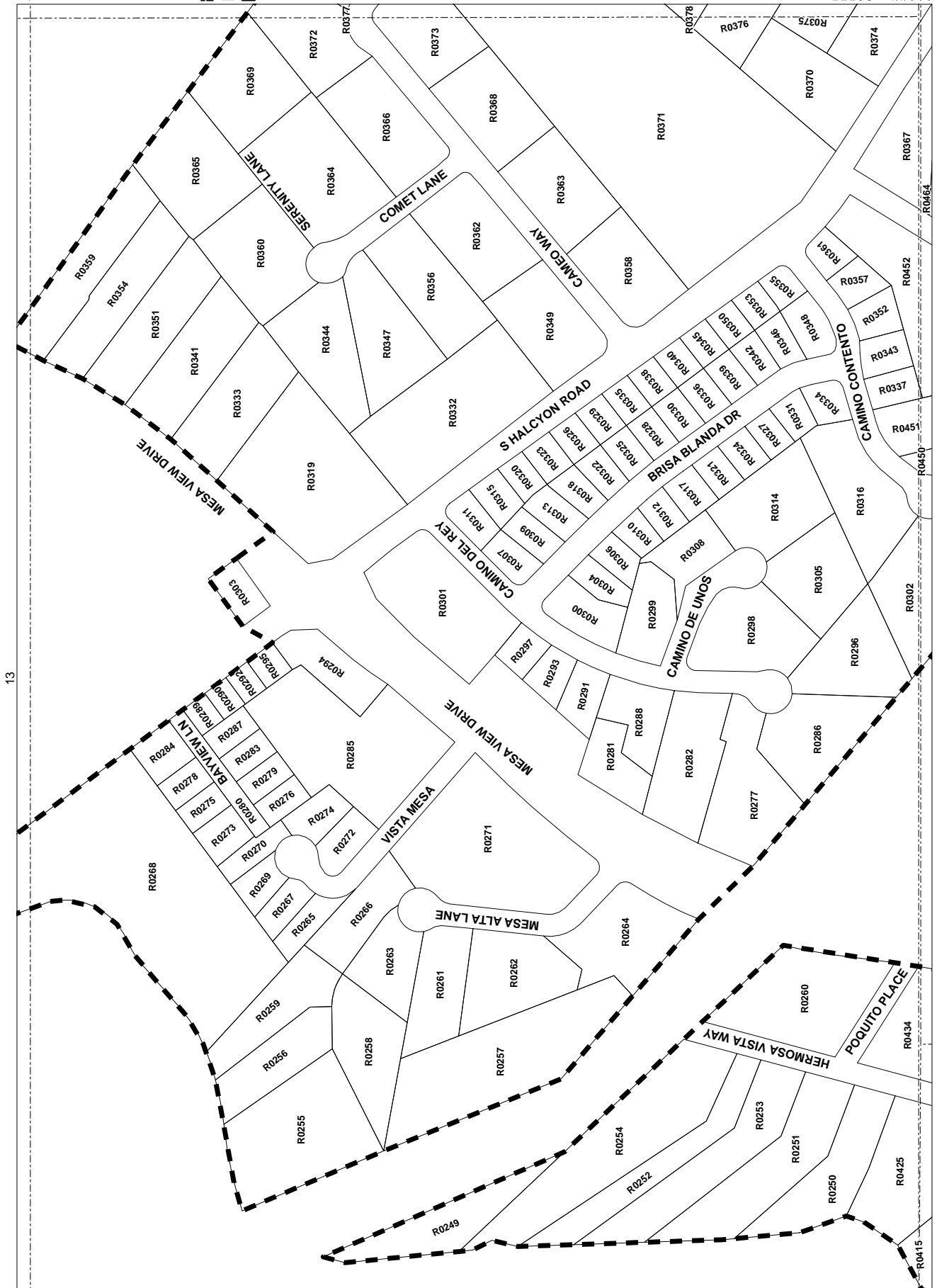



ASSESSMENT DIAGRAM

NIPOMO MESA
SUPPLEMENTAL
GENERAL PURPOSE
ASSESSMENT DISTRICT
NO.1

NIPOMO COMMUNITY
SERVICES DISTRICT
STATE OF CALIFORNIA

Legend

-  ASSESSOR PARCEL
-  ASSESSOR BOUNDARY
-  DIAGRAM SHEET

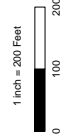

SHEET:
17 OF 28



LOTS ON THIS SHEET ARE
BASED ON ASSESSORS
MAP COUNTY OF SAN LUIS
OBISPO COUNTY OFFICE 15421,
0481042 051 061 150 151,
160, 161, 162, 164, 165, 171,
181, 202, 203, 204, 211, 241,
242, 243, 244, 245, 246,
364, 365, 380, 381, 382, 383,
400, 401, 402, 403, 404, 405,
406, 407, 408, 409, 410, 411,
412.

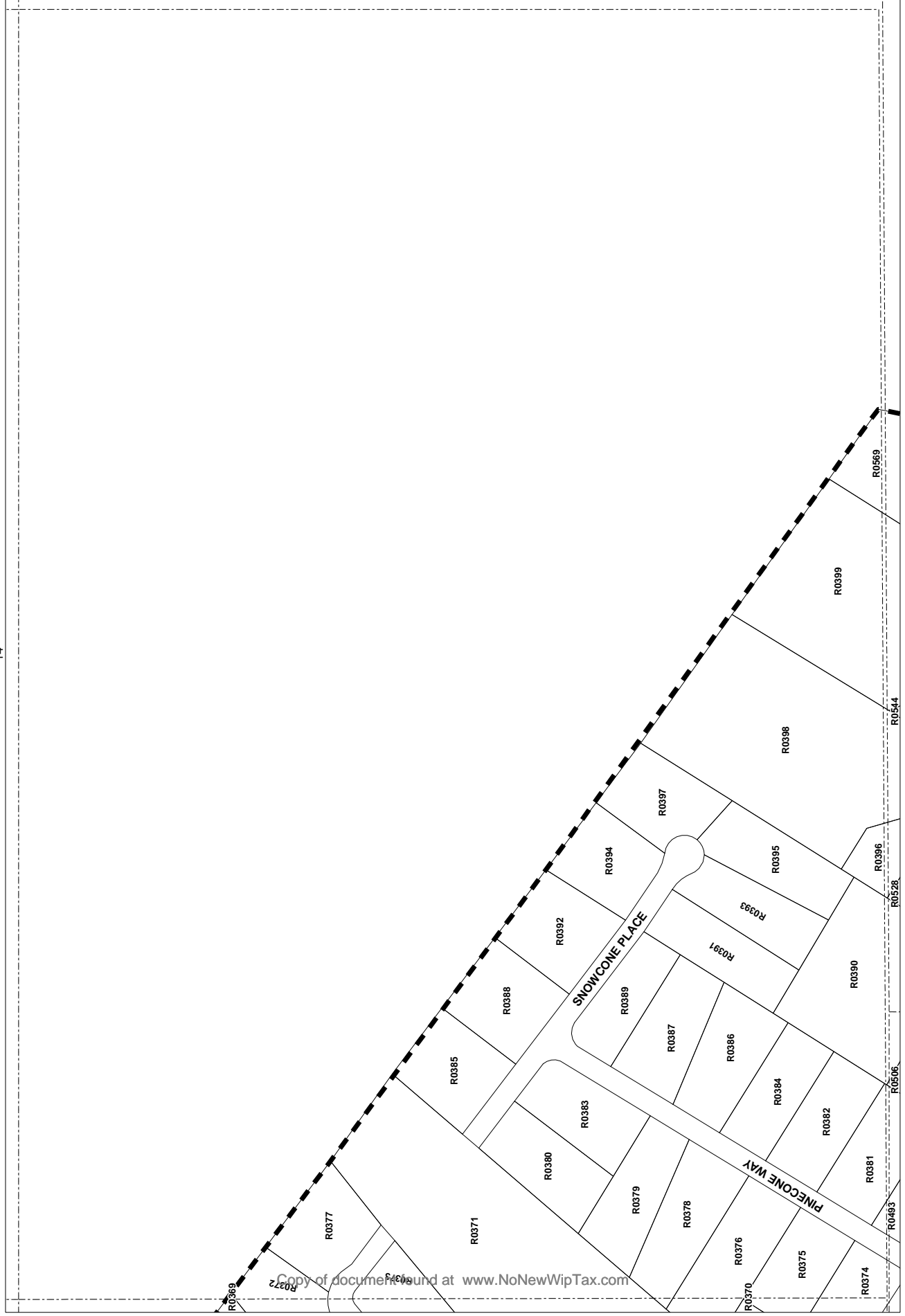





**ASSESSMENT
DIAGRAM**

NIPOMO MESA
SUPPLEMENTAL
SERVICES DISTRICT
ASSESSMENT DISTRICT
NO. 1

NIPOMO COMMUNITY
SERVICES DISTRICT
STATE OF CALIFORNIA

Legend

-  ASSESSOR PARCEL
-  ASSESSOR PARCEL
-  ASSESSOR PARCEL
-  ASSESSOR PARCEL



**SHEET:
18 OF 28**



LOTS ON THIS SHEET ARE
BASED ON ASSESSORS
MAP COUNTY OF SAN LUIS
OBISPO COUNTY OFFICE
04/1/02 051 061 150 151
160 161 162 164 165 171
181 202 203 204 211 241
251 252 253 254 255 256
364 365 380 381 382 383
400 401 402 403 404 405
406 407 408 409 410 411
412

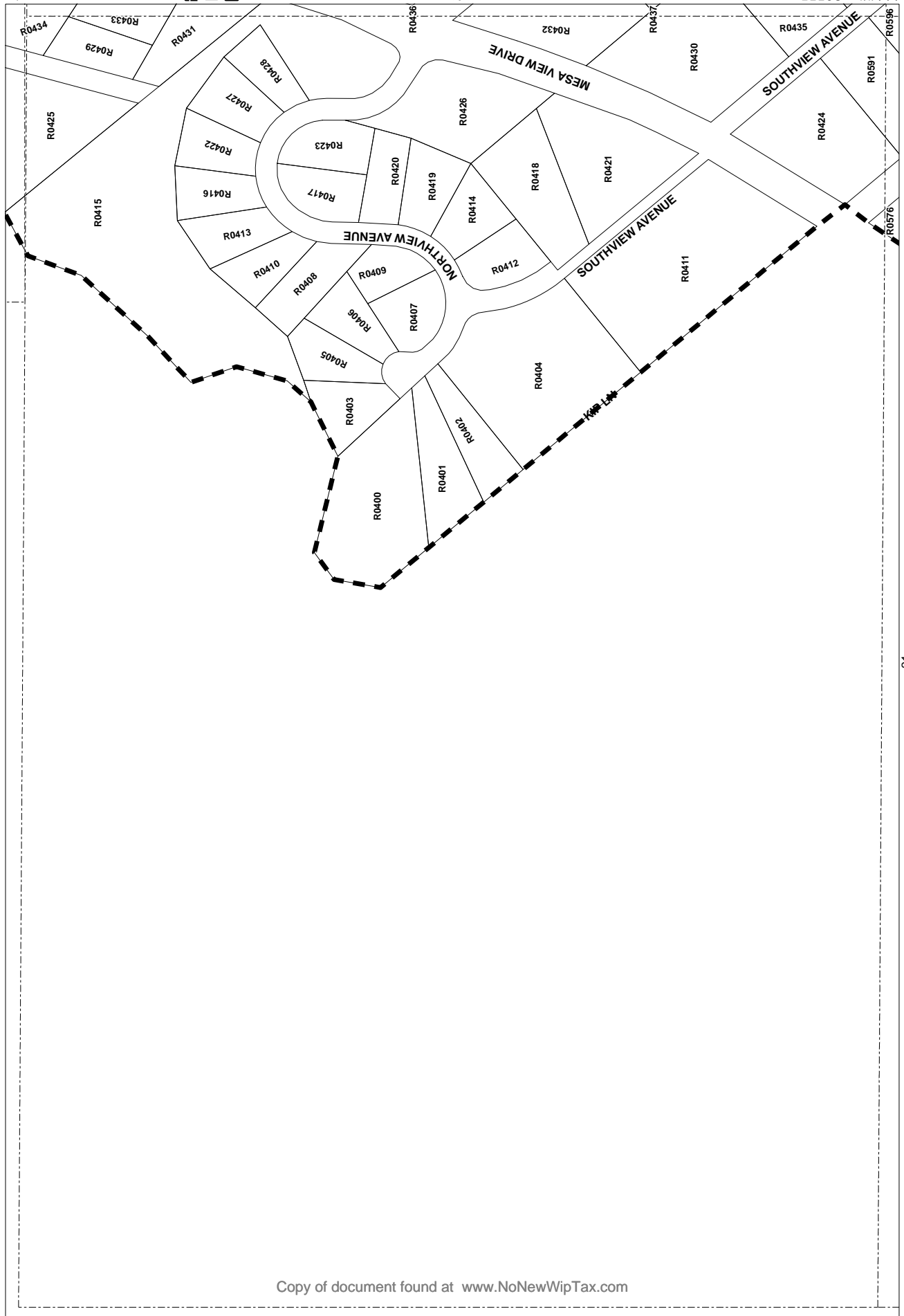

**ASSESSMENT
DIAGRAM**

NIPOMO MESA
SUPPLEMENTAL
ASSESSMENT DISTRICT
NO.1

NIPOMO COMMUNITY
SERVICES DISTRICT
STATE OF CALIFORNIA

Legend

-  ASSESSOR PARCEL
-  ASSESSOR BOUNDARY
-  DIAGRAM SHEET

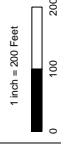

**SHEET:
20 OF 28**



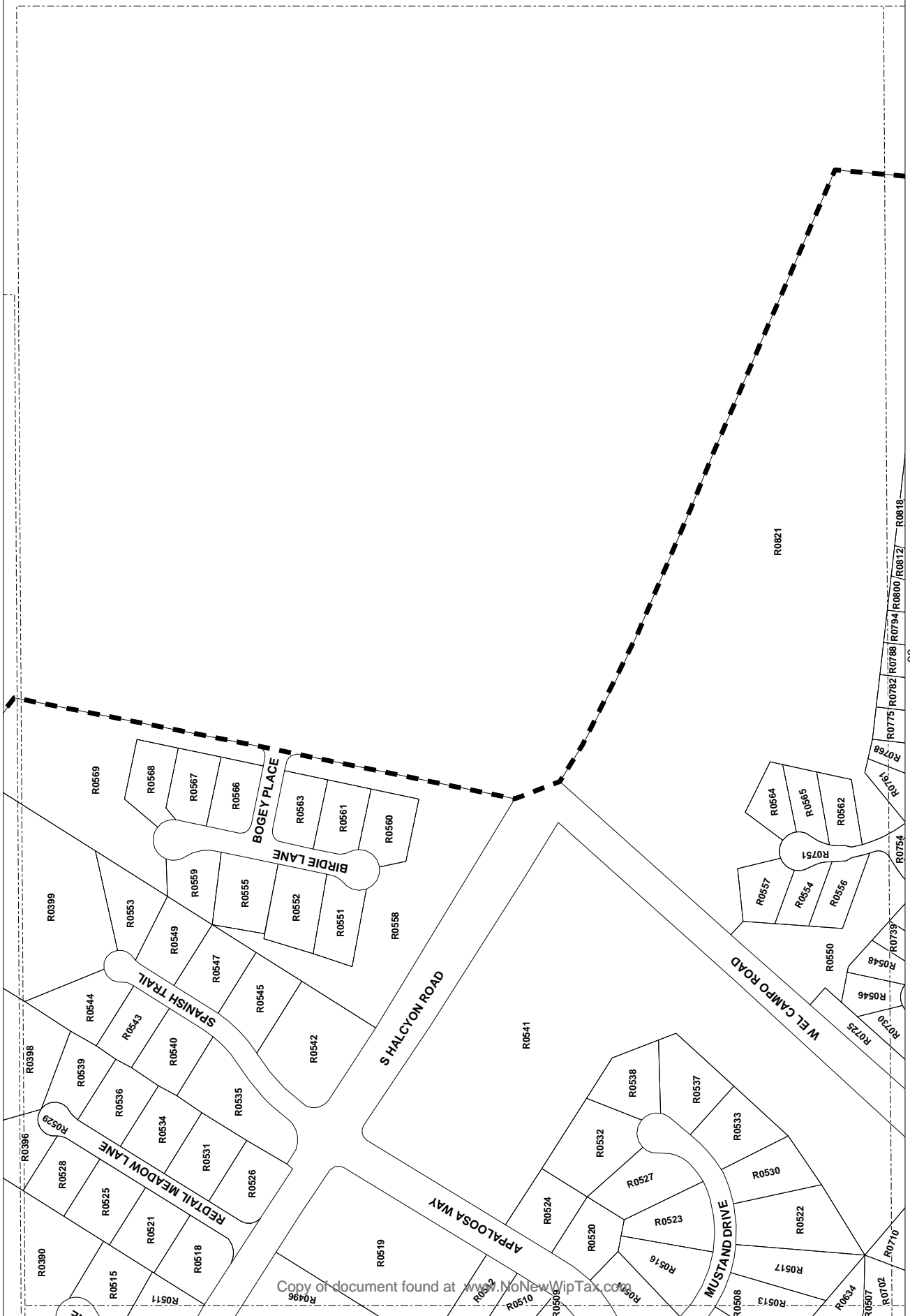

LOTS ON THIS SHEET ARE
BASED ON ASSESSORS
MAP COUNTY OF SAN LUIS
OBISPO COUNTY OFFICE 1981,
041, 042, 051, 061, 150, 151,
160, 161, 162, 164, 165, 171,
181, 202, 203, 204, 211, 241,
251, 252, 253, 254, 255,
364, 365, 390, 391, 392, 393,
400, 401, 402, 403, 404, 405,
406, 407, 408, 409, 410, 411,
412.



ASSESSMENT DIAGRAM

NIPOMO MESA
SUPPLEMENTAL
ASSESSMENT DISTRICT
NO.1
NIPOMO COMMUNITY
SERVICES DISTRICT
STATE OF CALIFORNIA

Legend

-  ASSESSOR PARCEL
-  ASSESSOR PARCEL
-  ASSESSOR PARCEL

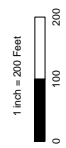

SHEET:
21 OF 28



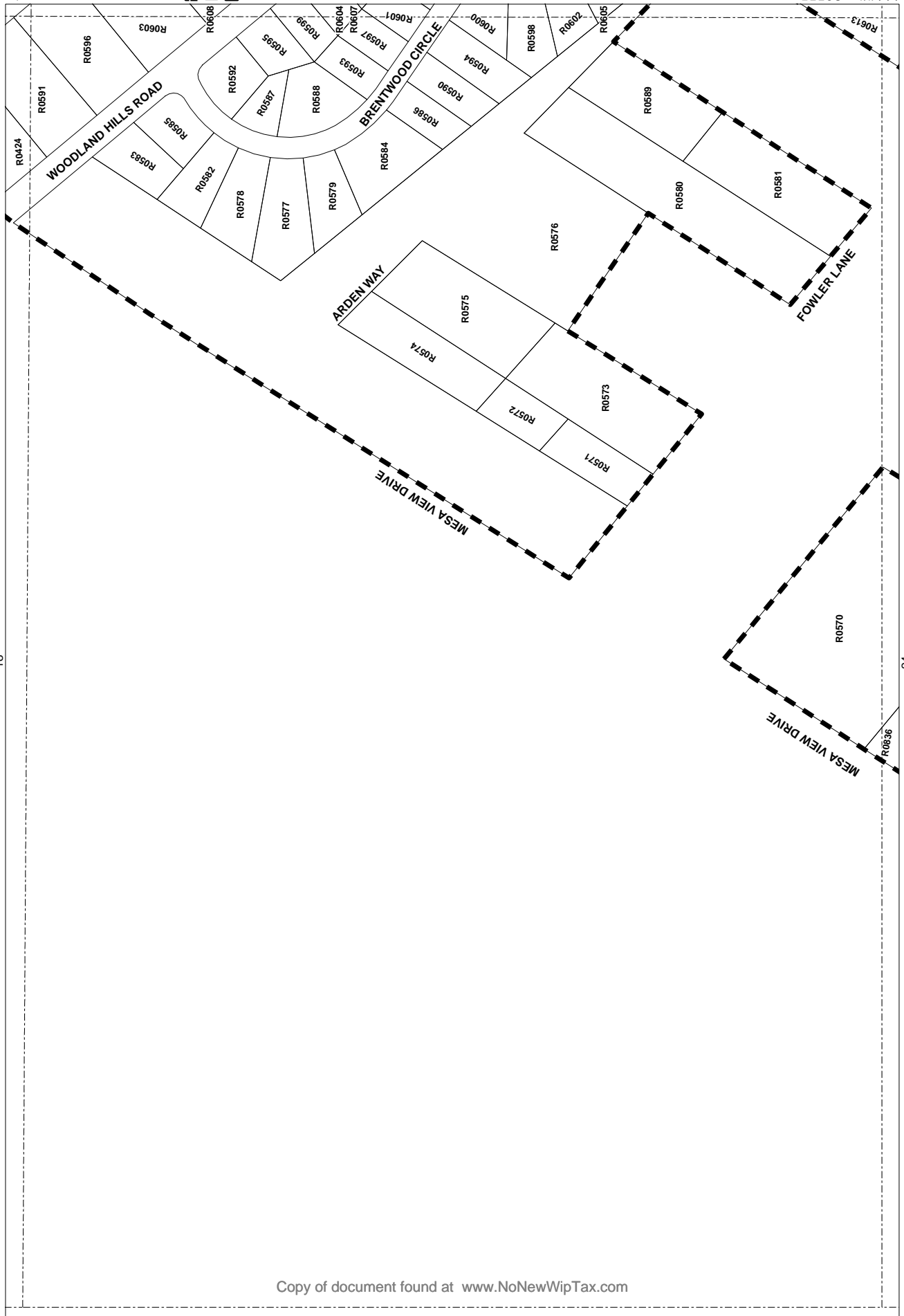

LOTS ON THIS SHEET ARE
BASED ON ASSESSORS
MAP COUNTY OF SAN LUIS
OBSOLETE MAPS: 001, 002, 003, 004, 005, 006, 007, 008, 009, 010, 011, 012, 013, 014, 015, 016, 017, 018, 019, 020, 021, 022, 023, 024, 025, 026, 027, 028, 029, 030, 031, 032, 033, 034, 035, 036, 037, 038, 039, 040, 041, 042, 043, 044, 045, 046, 047, 048, 049, 050, 051, 052, 053, 054, 055, 056, 057, 058, 059, 060, 061, 062, 063, 064, 065, 066, 067, 068, 069, 070, 071, 072, 073, 074, 075, 076, 077, 078, 079, 080, 081, 082, 083, 084, 085, 086, 087, 088, 089, 090, 091, 092, 093, 094, 095, 096, 097, 098, 099, 100, 101, 102, 103, 104, 105, 106, 107, 108, 109, 110, 111, 112, 113, 114, 115, 116, 117, 118, 119, 120, 121, 122, 123, 124, 125, 126, 127, 128, 129, 130, 131, 132, 133, 134, 135, 136, 137, 138, 139, 140, 141, 142, 143, 144, 145, 146, 147, 148, 149, 150, 151, 152, 153, 154, 155, 156, 157, 158, 159, 160, 161, 162, 163, 164, 165, 166, 167, 168, 169, 170, 171, 172, 173, 174, 175, 176, 177, 178, 179, 180, 181, 182, 183, 184, 185, 186, 187, 188, 189, 190, 191, 192, 193, 194, 195, 196, 197, 198, 199, 200, 201, 202, 203, 204, 205, 206, 207, 208, 209, 210, 211, 212, 213, 214, 215, 216, 217, 218, 219, 220, 221, 222, 223, 224, 225, 226, 227, 228, 229, 230, 231, 232, 233, 234, 235, 236, 237, 238, 239, 240, 241, 242, 243, 244, 245, 246, 247, 248, 249, 250, 251, 252, 253, 254, 255, 256, 257, 258, 259, 260, 261, 262, 263, 264, 265, 266, 267, 268, 269, 270, 271, 272, 273, 274, 275, 276, 277, 278, 279, 280, 281, 282, 283, 284, 285, 286, 287, 288, 289, 290, 291, 292, 293, 294, 295, 296, 297, 298, 299, 300, 301, 302, 303, 304, 305, 306, 307, 308, 309, 310, 311, 312, 313, 314, 315, 316, 317, 318, 319, 320, 321, 322, 323, 324, 325, 326, 327, 328, 329, 330, 331, 332, 333, 334, 335, 336, 337, 338, 339, 340, 341, 342, 343, 344, 345, 346, 347, 348, 349, 350, 351, 352, 353, 354, 355, 356, 357, 358, 359, 360, 361, 362, 363, 364, 365, 366, 367, 368, 369, 370, 371, 372, 373, 374, 375, 376, 377, 378, 379, 380, 381, 382, 383, 384, 385, 386, 387, 388, 389, 390, 391, 392, 393, 394, 395, 396, 397, 398, 399, 400, 401, 402, 403, 404, 405, 406, 407, 408, 409, 410, 411, 412.



**ASSESSMENT
DIAGRAM**

NIPOMO MESA
SUPPLEMENTAL
ASSESSMENT DISTRICT
NO.1

NIPOMO COMMUNITY
SERVICES DISTRICT
STATE OF CALIFORNIA

- Legend**
-  ASSM BOUNDARY
 -  ASSESSOR PARCEL
 -  DIAGRAM SHEET

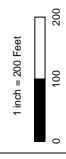

**SHEET:
23 OF 28**



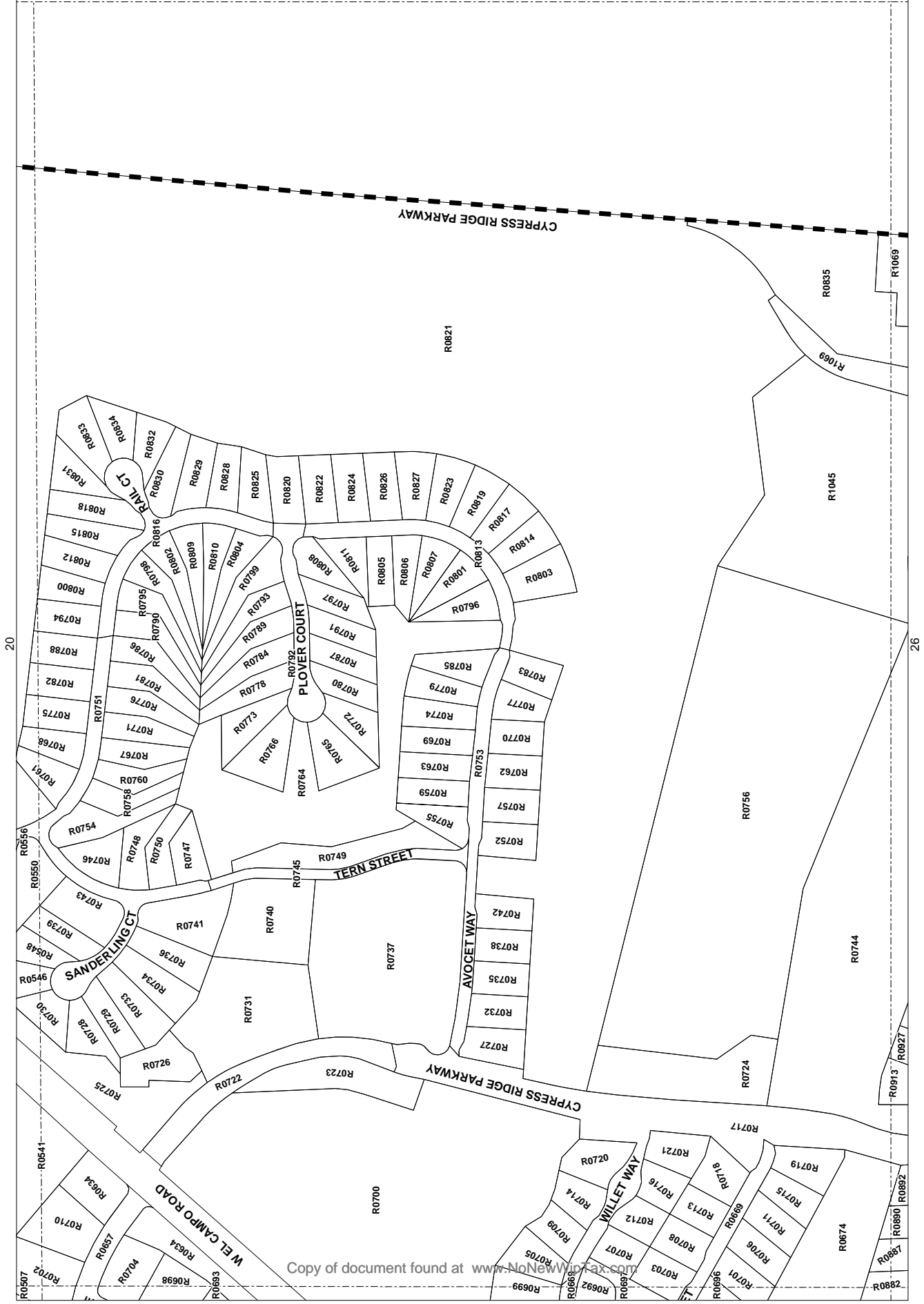

LOTS ON THIS SHEET ARE
BASED ON ASSESSORS
MAP COUNTY OF SAN LUIS
OBISPO COUNTY OFFICE
041,042,051,061,150,151,
160,161,162,164,165,171,
181,202,203,204,211,241,
242,243,244,245,246,
364,365,380,381,382,383,
400,401,402,403,404,405,
406,407,408,409,410,411,
412



**ASSESSMENT
DIAGRAM**

NIPOMO MESA
SUPPLEMENTAL
SERVICES DISTRICT
ASSESSMENT DISTRICT
NO.1

NIPOMO COMMUNITY
SERVICES DISTRICT
STATE OF CALIFORNIA

- Legend**
-  ASSM BOUNDARY
 -  ASSESSOR PARCEL
 -  DIAGRAM SHEET

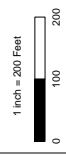

25

**SHEET:
24 OF 28**



LOTS ON THIS SHEET ARE
BASED ON ASSESSORS
MAP COUNTY OF SAN LUIS
OBERLIN 1997 001 001 001
0481 042 051 061 150 151
160 161 162 164 165 171
181 202 203 204 211 241
242 243 244 245 246
364 365 380 381 382 383
400 401 402 403 404 405
406 407 408 409 410 411
412

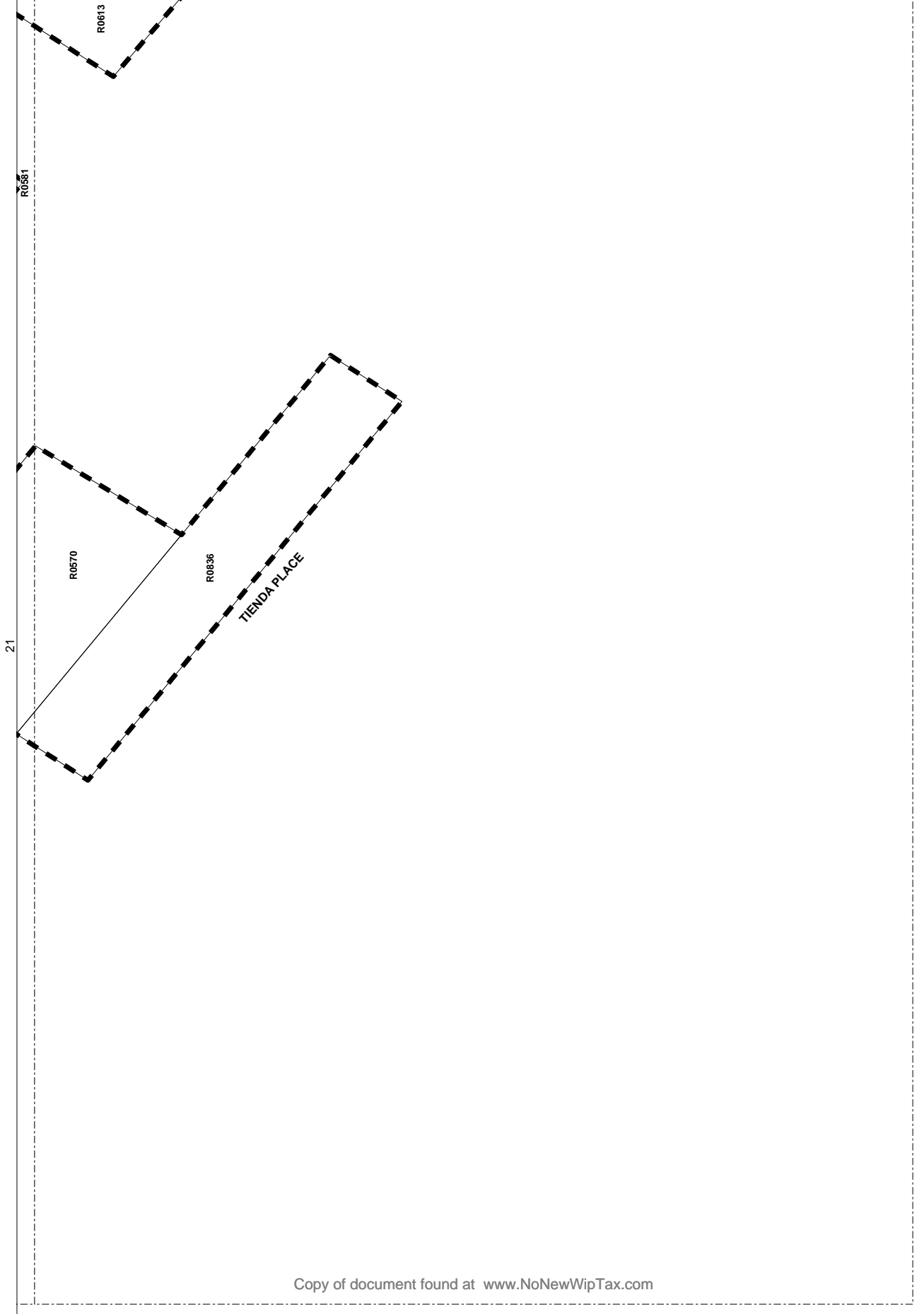



**ASSESSMENT
DIAGRAM**

NIPOMO MESA
SUPPLEMENTAL
ASSESSMENT DISTRICT
NO.1

NIPOMO COMMUNITY
SERVICES DISTRICT
STATE OF CALIFORNIA

Legend

-  ASSM BOUNDARY
-  ASSESSOR PARCEL
-  DIAGRAM SHEET

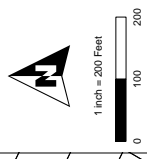

**SHEET:
25 OF 28**



LOTS ON THIS SHEET ARE
BASED ON ASSESSORS
MAP COUNTY OF SAN LUIS
OBSOLETE MAPS OF 1941,
041, 042, 051, 061, 150, 151,
160, 161, 162, 164, 165, 171,
181, 202, 203, 204, 211, 241,
242, 243, 244, 245, 246,
364, 365, 380, 381, 382, 383,
400, 401, 402, 403, 404, 405,
406, 407, 408, 409, 410, 411,
412.

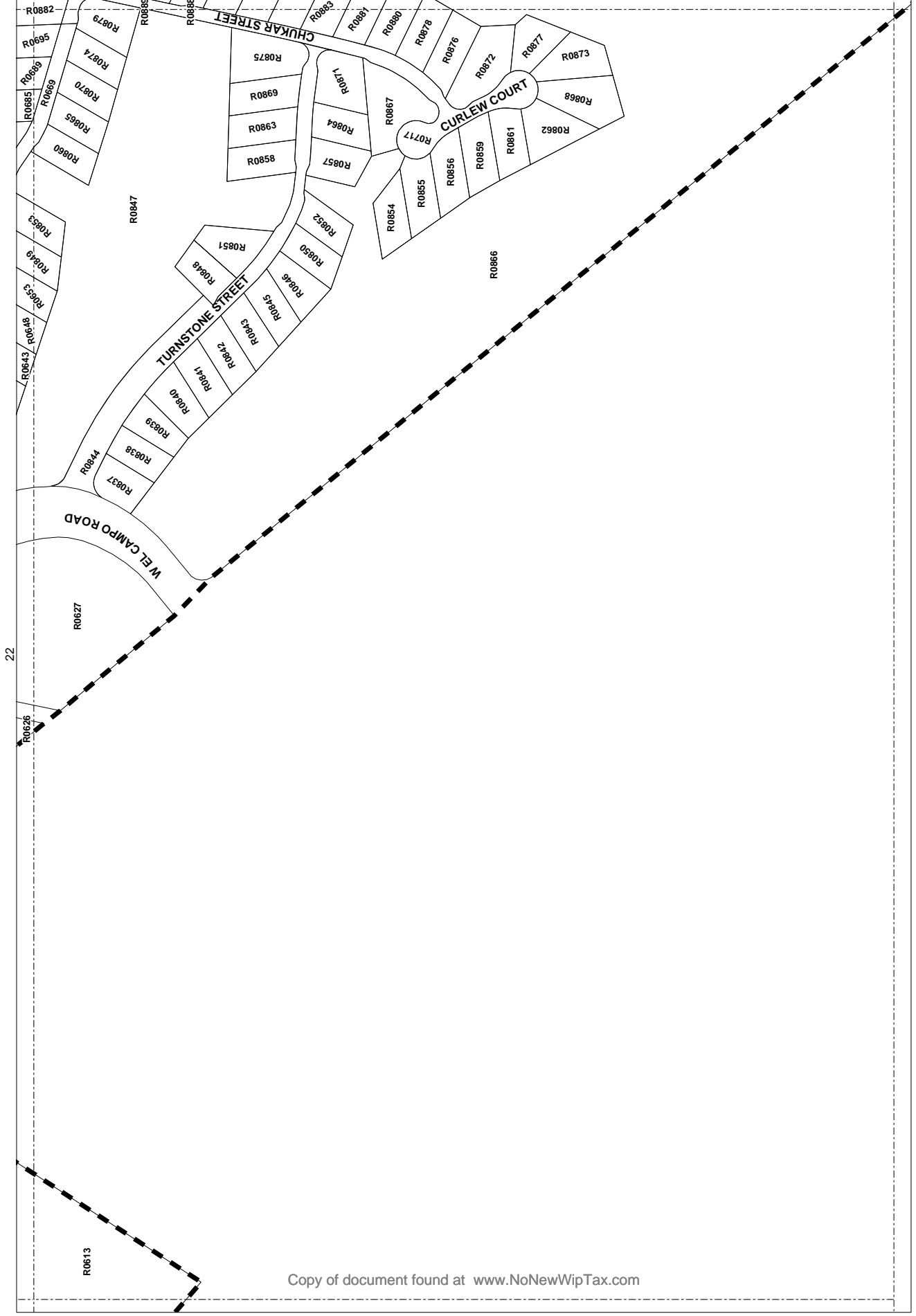



**ASSESSMENT
DIAGRAM**

NIPOMO MESA
SUPPLEMENTAL
MAPPING DISTRICT
ASSESSMENT DISTRICT
NO.1

NIPOMO COMMUNITY
SERVICES DISTRICT
STATE OF CALIFORNIA

28

Legend

-  ASSM BOUNDARY
-  ASSESSOR PARCEL
-  DIAGRAM SHEET

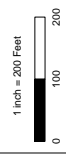

**SHEET:
27 OF 28**



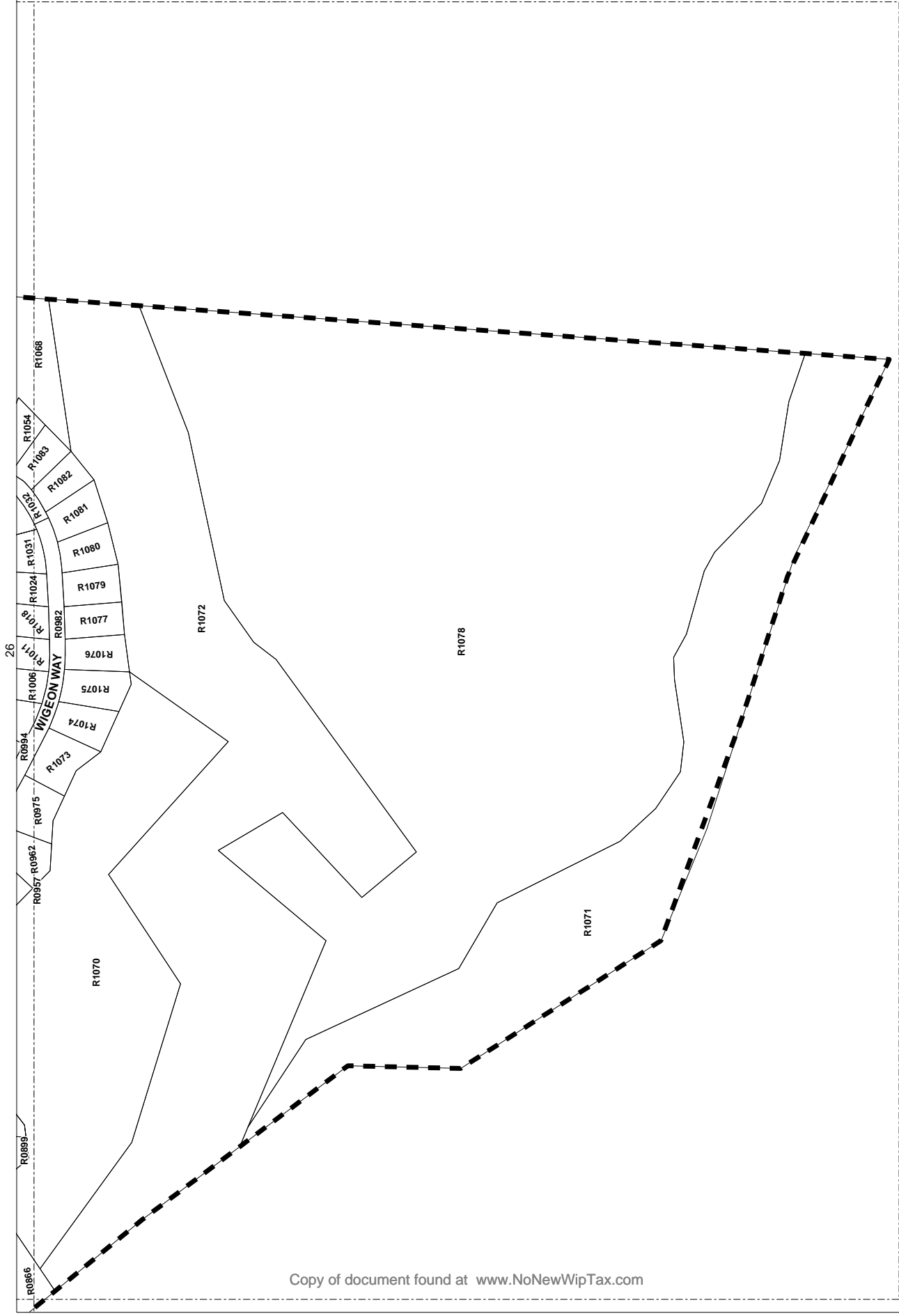

LOTS ON THIS SHEET ARE
BASED ON ASSESSORS
MAP COUNTY OF SAN LUIS
OBSOLETE MAP NO. 1421,
048, 049, 050, 051, 052,
160, 161, 162, 164, 165, 171,
181, 202, 203, 204, 211, 241,
242, 243, 244, 245, 246,
364, 365, 380, 381, 382, 383,
400, 401, 402, 403, 404, 405,
406, 407, 408, 409, 410, 411,
412.



**ASSESSMENT
DIAGRAM**

NIPOMO MESA
SUPPLEMENTAL
SERVICES DISTRICT
ASSESSMENT DISTRICT
NO.1

NIPOMO COMMUNITY
SERVICES DISTRICT
STATE OF CALIFORNIA

- Legend**
-  ASSESSOR PARCEL
 -  ASSESSOR BOUNDARY
 -  DIAGRAM SHEET

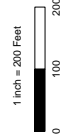

**SHEET:
28 OF 28**



LOTS ON THIS SHEET ARE
BASED ON ASSESSORS
MAP COUNTY OF SAN LUIS
OBISPO COUNTY, 1992-93
0491042 051 061 150 151
160 161 162 164 165 171
181 202 203 204 211 241
251 252 253 254 255 256
364 365 380 381 382 383
400 401 402 403 404 405
406 407 408 409 410 411
412

